

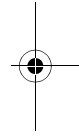

RadioShack®

www.radioshack.comSM

XL-260 High Power 4/3/2-Channel Bridgeable Amplifier

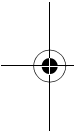

Owner's Manual
Please read before using this equipment.

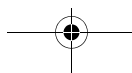
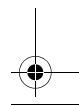
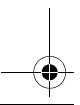

Contents

Features	3
Preparation	4
Supplied Hardware	4
Choosing a Mounting Location	4
Preparing the Mounting Area	5
Routing Cables and Wires	5
Installation Order	5
Before You Make the Connections	5
Connecting Ground and Switched/Primary Power	7
Connecting Inputs	8
Low-Level Inputs	8
High-Level (Speaker Wire) Inputs	9
Four Speaker Outputs	10
Two Speaker Outputs	11
Connecting Speakers	12
Preparing the Speaker Wires	12
Connecting Four Speakers	13
Connecting Two Speakers (Unbridged Connection)	13
Connecting Two Speakers (Bridged Connection)	14
Connecting Two Speakers and One Subwoofer (Unbridged Connection)	14
Connecting Two Unbridged Speakers and One Bridged Subwoofer	15
Completing the Installation	16
Testing the Connections	16
Mounting the Amplifier	16
Operation	18
Turning On the Amplifier	18
Adjusting the Audio Level	18
Adjusting Frequency Crossover	19
Troubleshooting	20
Care	22
Replacing a Fuse	22
Replacing the SFE-Type Fuse	22
Replacing the Blade-Type Fuses	22
Specifications	23

□ Features

Your RadioShack High Power 4/3/2-Channel Bridgeable Amplifier produces a total of 260 watts to give added punch and power to your vehicle's existing auto sound system.

The amplifier produces up to 130 watts per channel (if bridged) of clean, powerful sound at all audio frequencies with minimum distortion. You can connect your auto sound system's low-level or speaker-level outputs to this amplifier.

Its features include:

14K Gold-Plated Noise-Isolated Low-Level Input Jacks — let you connect low-level (preamplifier) signal inputs to match your auto sound system's output for the best high-fidelity performance.

14K Gold-Plated Speaker Terminals — designed for low impedance, high conductivity, and minimum corrosion, to provide the highest signal transfer and lowest sound distortion.

Input Level Controls — let you adjust the level of the audio signals that enter the amplifier.

Automatic Power Switching — can automatically turn the amplifier on or off when you turn your auto sound system on or off (depending on how you hook up the amplifier).

Bridging Capability — lets you combine the amplifier's four 65-watt channels so you can use the amplifier with only two channels that produce a total of 130 watts from each channel.

Mute Turn On Circuit — eliminates the thump you hear when you turn on some amplifiers.

Power Indicator — lights when power is supplied to the amplifier.

Protection Indicator — lights if the amplifier shuts itself down.

Crossover Frequency Circuit — lets you adjust the crossover frequency from 45–400 Hz. This lets you set up the amplifier so you can connect a subwoofer.

Short Circuit Protection — distorts the amplifier's sound if any output channel shorts, alerting you to turn off the auto sound system.

Auto-Off — temporarily shuts down the amplifier to protect the amplifier from overheating or input overloads. The amplifier restarts automatically when it cools or the problem is corrected.

THE FCC WANTS YOU TO KNOW

Your amplifier might cause TV or radio interference even when it is operating properly. To determine whether your amplifier is causing the interference, turn off your amplifier. If the interference goes away, your amplifier is causing it. Try to eliminate the interference by:

- moving your amplifier away from the receiver
- contacting your local RadioShack store for help

If you cannot eliminate the interference, the FCC requires that you stop using your amplifier.

□ Preparation

SUPPLIED HARDWARE

Your amplifier comes with the following items. Be sure you locate everything shown before you store or dispose of the packing materials.

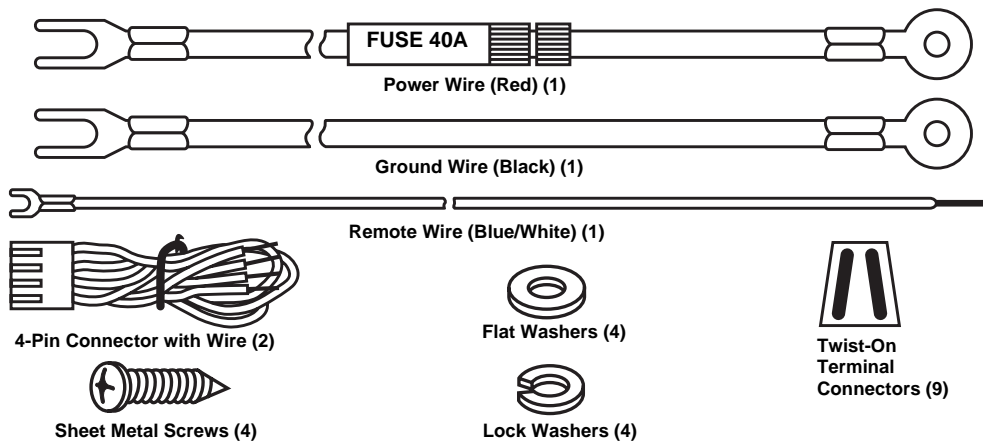

BEFORE YOU BEGIN THE INSTALLATION

Before you install your amplifier, read all the instructions in this owner's manual. You should be able to answer all of these questions about your vehicle's electrical and auto sound systems.

- Does my vehicle have an auto sound system, such as a car stereo or CD player, already installed? (You must have an existing auto sound system to use this amplifier.)
- How do I connect a wire to the fuse box?
- Which of the auto sound system's wires is the power wire?
- Which of the auto sound system's terminals are low-level outputs and which are high-level (speaker) outputs?

Also, be aware that installation in your vehicle might require cutting or modifying your vehicle.

Choosing a Mounting Location

A good location for mounting the amplifier is in your vehicle's trunk. Wherever you decide to mount it, choose a mounting location that:

- Does not interfere with the vehicle's operation
- Lets you drill mounting holes without damaging other vehicle components
- Allows enough space around the cooling fins for proper airflow and cooling
- Lets you easily see the amplifier's POWER and PROTECTION indicators

Warning: The amplifier gets very hot while it is on. Do not touch the amplifier or place flammable objects near it.

Preparing the Mounting Area

Before you mount the amplifier, make sure you have these materials.

- an adapter harness
- additional wire
- shielded audio cables
- 16- or 18-gauge marked or color-coded wires

Then confirm that the amplifier fits in your vehicle's available mounting area. This amplifier requires a 5¹/₂-inch high by 13¹/₂-inch wide by 17¹/₂-inch deep (13.9 × 34.3 × 43.1 cm) mounting area with adequate ventilation space.

Routing Cables and Wires

Avoid routing the connection cables and any speaker wires near moving parts or sharp edges. You can usually route wires and cables along the wiring channel beneath the vehicle's door facings by carefully removing the molding that holds the carpet in place. After routing the cables and wires, replace the molding.

INSTALLATION ORDER

For trouble-free installation, simply follow the sections in this owner's manual in order. First make all the connections by temporarily connecting the amplifier to:

- 1 Ground and power
- 2 Your auto sound system's outputs
- 3 Your speakers

Then test the connections. When you verify that everything works as expected, disconnect the amplifier, mount it in your vehicle, and reconnect it.

Caution: If you do not make the connections in the order shown, damage to the amplifier and your auto sound system is possible if any wire connections are made incorrectly.

Note: For easier installation, mark each wire you plan to connect with the name of the terminal you will connect it to.

BEFORE YOU MAKE THE CONNECTIONS

The supplied connection cables include all the lead wires you need to connect the amplifier to ground, power, and your existing auto sound system.

Important:

- Do not cut these wires. If you cut any wire, you cannot obtain a refund or exchange on this product. However, RadioShack *will* provide warranty service if you cut a wire and find the product is defective.
- If the connectors on your vehicle's auto sound system are not compatible with the amplifier's connectors, you might need an adapter harness to complete the connections. RadioShack stores sell adapter harnesses for most vehicles.

You might need additional wire, depending on your individual auto sound system, to complete the connections. Your local RadioShack store carries a full line of wire and wire management accessories.



Cautions:

- For added safety and to protect your amplifier and auto sound system, disconnect the cable from your vehicle's negative (-) battery terminal before you begin.
- Be sure your speakers can handle as much as 260 watts of power (130 watts per channel if you connect your auto sound system to one pair of speakers and bridge the amplifier's outputs, or 65 watts per channel if you connect your auto sound system to two pairs of speakers or one pair of speakers and a subwoofer). Each speaker must have an impedance of at least 4 ohms. Your local RadioShack store carries a full line of speakers.

To make it easier to gauge wire length and connect the amplifier, temporarily place the amplifier as close as possible to the selected mounting location.

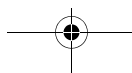
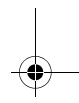
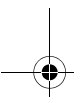
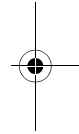
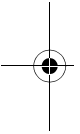

CONNECTING GROUND AND SWITCHED/PRIMARY POWER

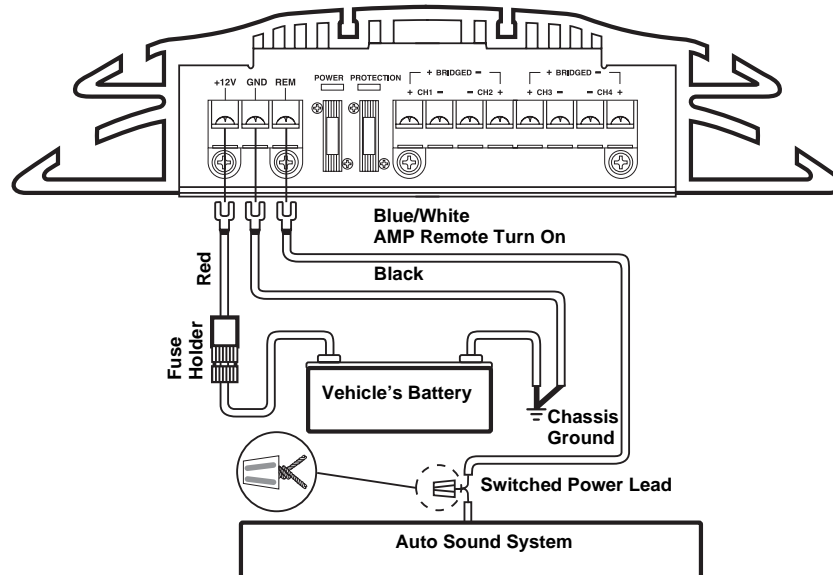

Follow these steps to connect the amplifier to ground, switched power, and primary power.

1. If you have not done so already, disconnect the cable from your vehicle's negative (-) battery terminal.
2. Use a screwdriver to connect the spade end of the supplied black ground wire to the amplifier's **GND** (ground) terminal.
3. Connect the black ground wire's other end to a chassis ground, such as a metal bolt attached to a metal part of the vehicle's frame. Be sure the bolt is not insulated from the chassis by a plastic part.
4. Use a screwdriver to connect the spade end of the supplied blue/white wire to the amplifier's **REM** (remote power) terminal.
5. *If your auto sound system has a switched power lead, connect the blue/white wire's other end to your auto sound system's switched power lead*

using one of the supplied twist-on terminal connectors.

This connection turns on the amplifier when you turn on the auto sound system, and turns off the amplifier when you turn off the auto sound system. This prevents your vehicle's battery from being drained if you leave your amplifier on when you turn off your auto sound system.

If your auto sound system does not have a switched power lead, connect the blue/white wire's other end to a point in your vehicle's fuse block that has power only when you turn on the ignition or turn the key to ACC.

This connection turns on the amplifier when you turn on the ignition or turn the key to ACC, and turns off the amplifier when you turn off the ignition. This prevents your vehicle's battery from being drained if you leave your amplifier on when you turn off the ignition.

6. Use a screwdriver to connect the spade end of the supplied red power cable (with in-line fuse holder) to the amplifier's + 12V terminal.
7. Connect the other end of the red power cable to your vehicle's positive (+) battery terminal as shown. Then tighten the terminal.

Caution: Due to the amplifier's high current requirement, you must connect the red power cable's fused end directly to the vehicle's positive (+) battery terminal or damage to your vehicle's wiring could result.

Do not reconnect your vehicle's negative (-) battery cable yet.

□ Connecting Inputs

LOW-LEVEL INPUTS

You can connect your auto sound system's low-level line out jacks to the amplifier's low-level line in jacks.

If your auto sound system does not have low-level line out jacks, see "High-Level (Speaker Wire) Inputs" on Page 9 to connect your amplifier.

Note: For the best results, use shielded audio cables (not supplied) available at your local RadioShack store.

1. Temporarily place the amplifier as close as possible to the selected mounting location.
2. *If your auto sound system has four separate line out jacks, connect the auto sound system to the amplifier.*

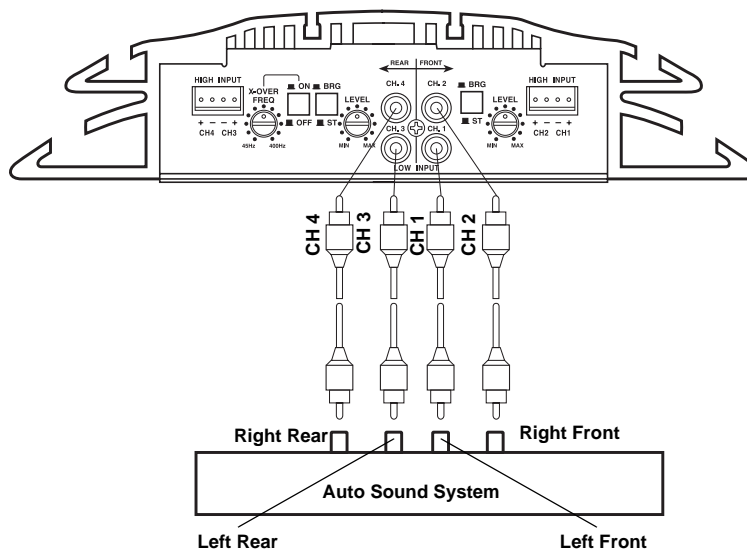

If your auto sound system has two line out jacks (left and right), connect the auto sound system to the amplifier.

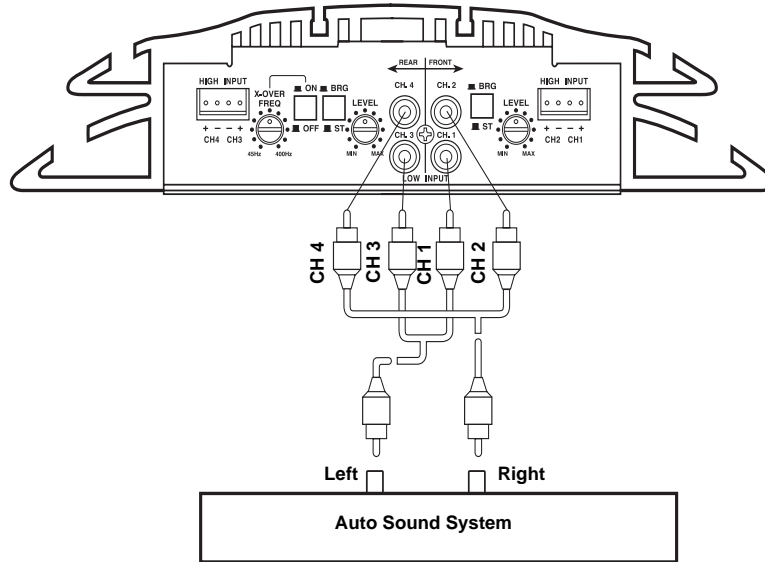

Note: For the best results, use shielded audio Y-adapters (not supplied) available at your local RadioShack store.

HIGH-LEVEL (SPEAKER WIRE) INPUTS

using either a floating or common ground connection.

If your auto sound system does not have low-level line out jacks but has only speaker outputs, connect your auto sound system's speaker outputs to the amplifier's **HIGH INPUT** jacks.

Note: A floating ground connection lets the amplifier provide more power to each speaker, but requires that you connect a separate wire to each speaker terminal. A common ground connection lets you use fewer wires to connect the speakers to the amplifier, but reduces the amount of power supplied to the speakers from the amplifier.

- If your auto sound system has four speaker outputs, see "Four Speaker Outputs" on Page 10 to connect your system's speaker outputs to the amplifier using either a floating or common ground connection.
- If your auto sound system has two speaker outputs, see "Two Speaker Outputs" on Page 11 to connect your system's speaker outputs to the amplifier

Use the supplied wire harnesses and the supplied twist-on terminal connectors to make the appropriate connections.

Four Speaker Outputs Floating Ground Connection

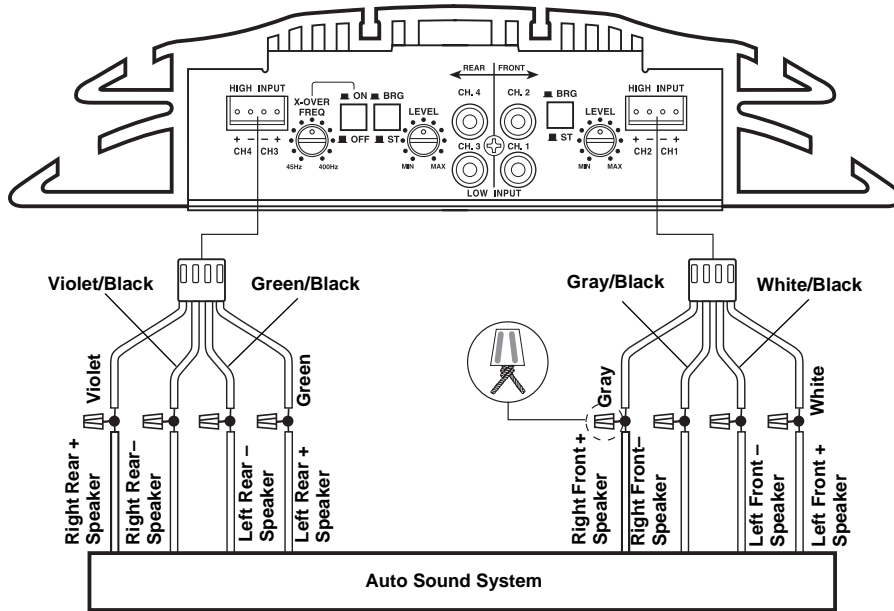

Common Ground Connection

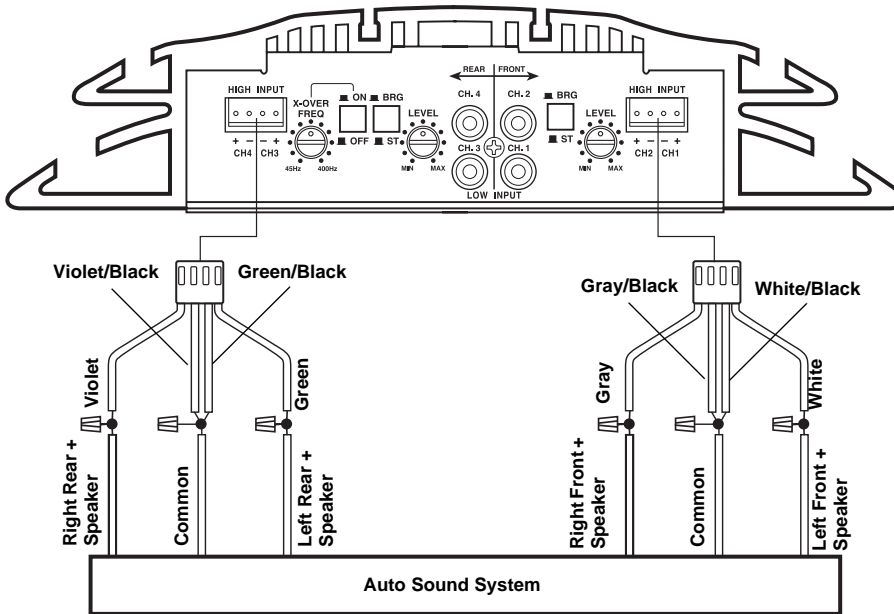

Two Speaker Outputs

Floating Ground Connection

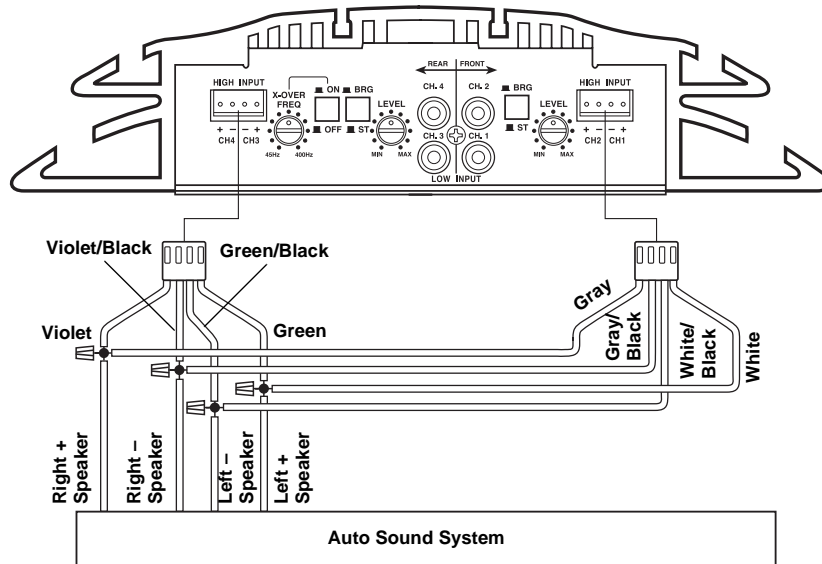

Common Ground Connection

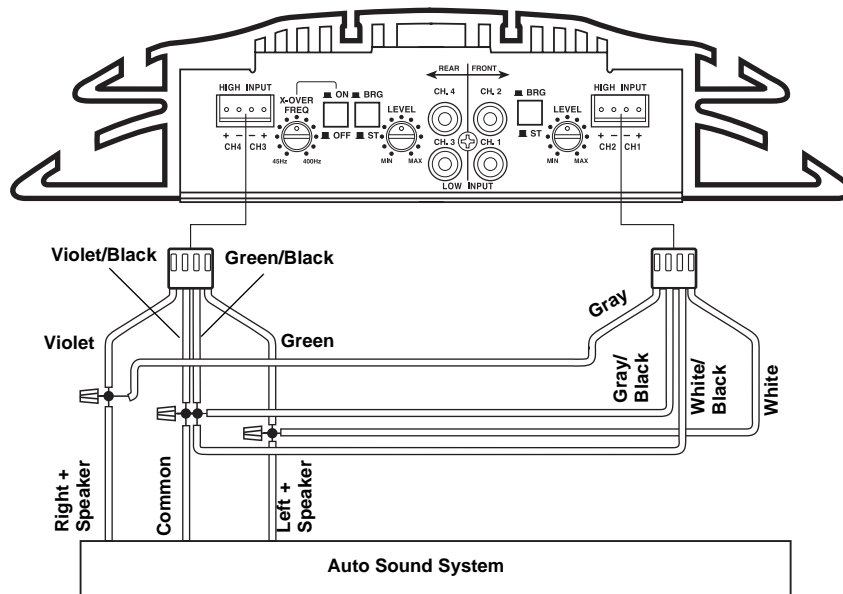

CONNECTING SPEAKERS

You can connect four speakers, two speakers and a subwoofer, or just two speakers to the amplifier and your auto sound system.

Important: Before you make the connections, make sure both **BRG/ST** switches (on the left and right sides of the amplifier) are set to **ST**.

Preparing the Speaker Wires

Caution: You must connect a separate wire to each speaker terminal as described in the following procedures. Unless your auto sound system's speakers use a common ground wire, do not use a common wire or chassis ground for speaker connections.

Notes:

- We recommend you use 16- or 18-gauge marked or color-coded wires to help you correctly connect the speakers to your amplifier.
 - Color-coded wires have a stripe running down one of the conductors or different colored insulation for each conductor. Your local RadioShack store has a wide selection of speaker wire.
 - For the maximum bass response and the best overall performance, keep your speakers properly phased (connect + to + and - to -).
1. With the speakers placed in their approximate locations, run one wire from each speaker to the amplifier.

If you are connecting a subwoofer, run two wires from each of the subwoofer's terminals to the amplifier.

2. Separate each wire's two conductors at both ends for a length of about 4 inches.

3. Strip the insulation from the ends of each conductor to expose $\frac{1}{4}$ inch of wire. Twist the ends to secure loose strands.

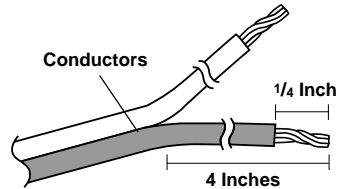

Connecting Four Speakers

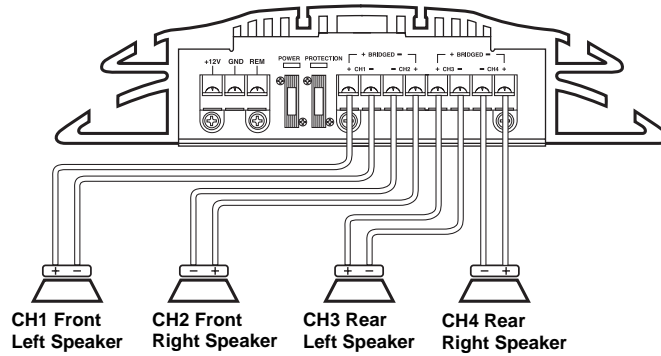

1. Use a screwdriver to connect the front left speaker's positive (+) wire to the amplifier's **CH1 (+)** terminal.
(-) wires to the amplifier's **CH2 (+)** and **CH2 (-)** terminals.
2. Use a screwdriver to connect the front left speaker's negative (-) wire to the amplifier's **CH1 (-)** terminal.
3. Repeat Steps 1–2 to connect the front right speaker's positive (+) and negative (-) wires to the amplifier's **CH2 (+)** and **CH2 (-)** terminals.
4. Repeat Steps 1–3 to connect the rear left and rear right speaker's positive (+) and negative (-) wires to the amplifier's **CH3 (+)**, **CH3 (-)**, **CH4 (+)**, and **CH4 (-)** terminals.

Connecting Two Speakers (Unbridged Connection)

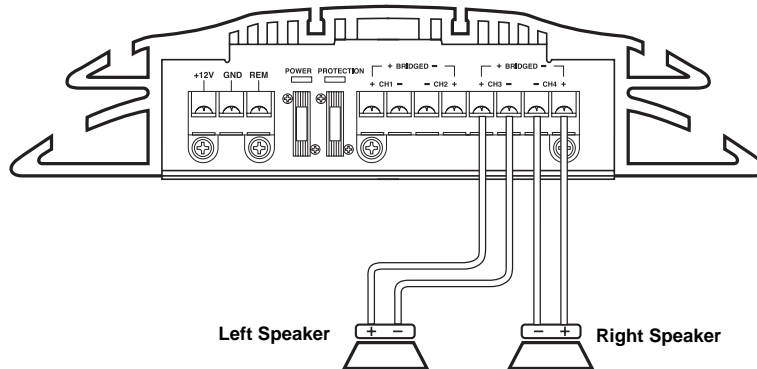

If you do not have high-power speakers, use this connection. This connection produces 65 watts per channel.

1. Use a screwdriver to connect the left speaker's positive (+) wire to the amplifier's **CH3 (+)** terminal.
2. Use a screwdriver to connect the left speaker's negative (-) wire to the amplifier's **CH3 (-)** terminal.
3. Repeat Steps 1–2 to connect the right speaker's positive (+) and negative (-) wires to the amplifier's **CH4 (+)** and **CH4 (-)** terminals.

Connecting Two Speakers (Bridged Connection)

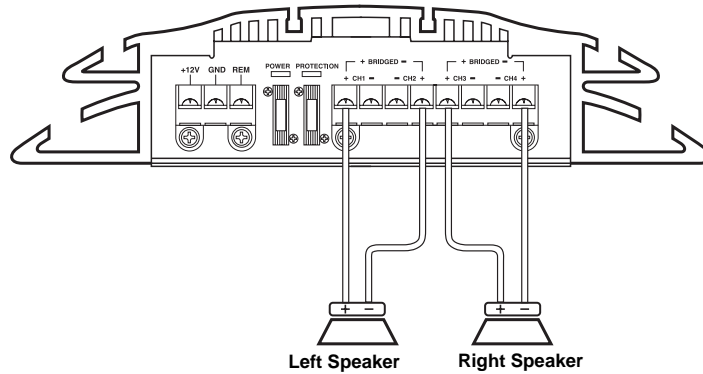

Caution: This connection produces 130 watts per channel. Use this connection only if you have high-power speakers that can handle a power output of 130 watts.

Note: CH2 (+) and CH4 (+) are used as negative (-) terminals for a bridged connection.

1. Use a screwdriver to connect the left speaker's positive (+) wire to the amplifier's CH1 (+) terminal.
2. Use a screwdriver to connect the left speaker's negative (-) wire to the amplifier's CH2 (+) terminal.
3. Repeat Steps 1–2 to connect the right speaker's positive (+) and negative (-) wires to the amplifier's CH3 (+) and CH4 (+) terminals.
4. Set both **BRG/ST** switches (on the left and right sides of the amplifier) to **BRG**.

Connecting Two Speakers and One Subwoofer (Unbridged Connection)

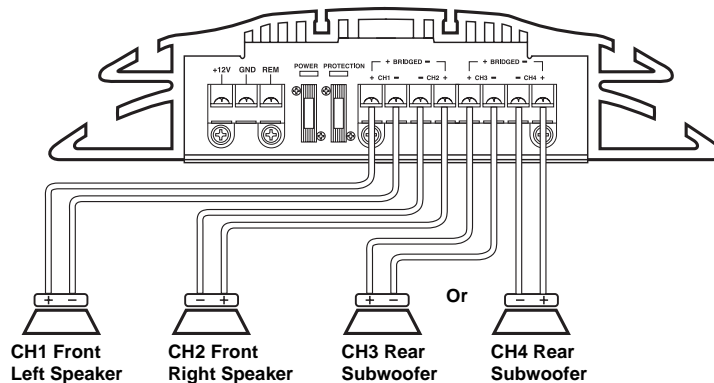

1. Use a screwdriver to connect the front left speaker's positive (+) wire to the amplifier's CH1 (+) terminal.
2. Use a screwdriver to connect the front left speaker's negative (-) wire to the amplifier's CH1 (-) terminal.

3. Repeat Steps 1–2 to connect the front right speaker's positive (+) and negative (–) wires to the amplifier's **CH2 (+)** and **CH2 (–)** terminals.
4. Use a screwdriver to connect the subwoofer's positive (+) wire to the amplifier's **CH3 (+)** or **CH4 (+)** terminal.
5. Repeat Step 4 to connect the subwoofer's negative (–) wire to the amplifier's negative (–) terminal for the same channel you connected in Step 4. For example, if you connected the subwoofer's positive (+) wire to the amplifier's **CH3 (+)** terminal, connect the subwoofer's negative (–) wire to the amplifier's **CH3 (–)** terminal.

Connecting Two Unbridged Speakers and One Bridged Subwoofer

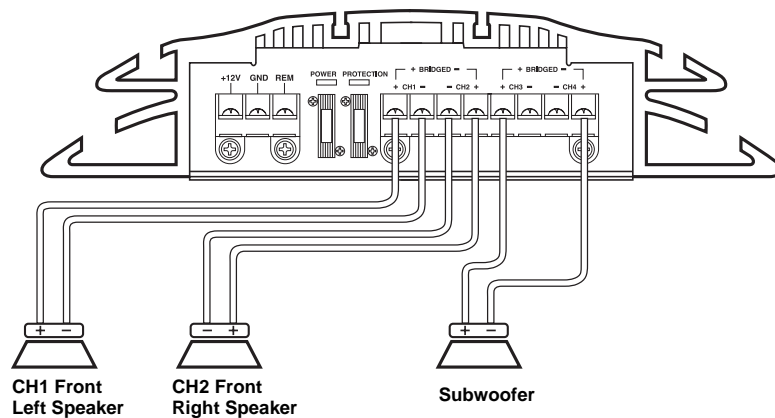

Note: **CH4 (+)** is used as a negative (–) terminal for a bridged connection.

1. Use a screwdriver to connect the left front speaker's positive (+) wire to the amplifier's **CH1 (+)** terminal.
2. Use a screwdriver to connect the left front speaker's negative (–) wire to the amplifier's **CH1 (–)** terminal.
3. Repeat Steps 1–2 to connect the right front speaker's positive (+) and negative (–) wires to the amplifier's **CH2 (+)** and **CH2 (–)** terminals.
4. Use a screwdriver to connect the subwoofer's positive (+) wire to the amplifier's **CH3 (+)** terminal.
5. Repeat Step 4 to connect the subwoofer's negative (–) wire to the amplifier's **CH4 (+)** terminal.
6. Make sure the **BRG/ST** switch on the *right* side of the amplifier is set to **ST**, then set the **BRG/ST** switch on the *left* side of the amplifier to **BRG**.

□ **Completing the Installation**

TESTING THE CONNECTIONS

Before you continue, make sure you have securely made all connections. Then reconnect the cable to the vehicle's negative (-) battery terminal.

Set **LEVEL (MIN/MAX)** on the left and right sides of the amplifier to its mid position (see "Adjusting the Audio Level" on Page 18). Then turn on your vehicle's ignition and auto sound system to confirm that the amplifier

and auto sound system operate properly. The amplifier turns on after a few seconds.

If you cannot quickly confirm whether the auto sound system and amplifier are working properly, **turn off your vehicle's ignition and disconnect the cable from your vehicle's negative (-) battery terminal.** Then recheck your connections.

After you test the auto sound system and amplifier and verify that everything is properly connected and working, follow the instructions in "Mounting the Amplifier."

MOUNTING THE AMPLIFIER

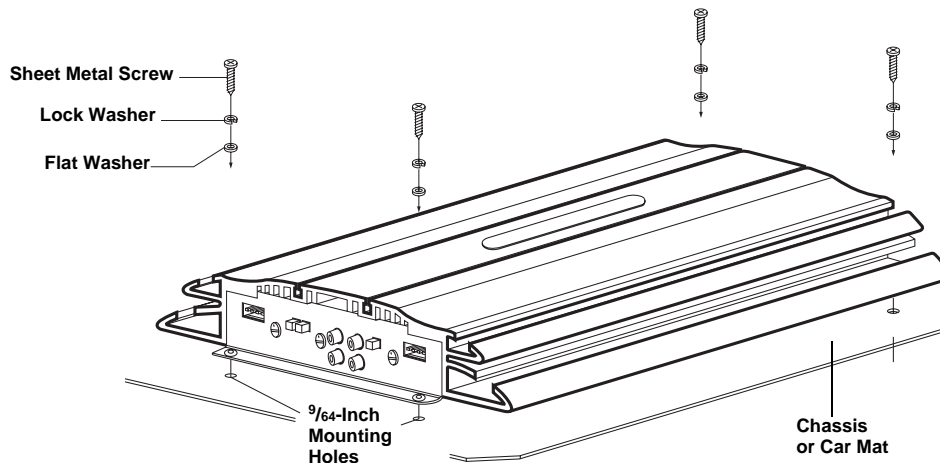

Once you verify that the amplifier is connected properly, follow these steps to mount it.

1. Disconnect the cable from the vehicle's negative (-) battery terminal.
2. To make mounting more convenient, temporarily disconnect the amplifier's connections (ground, primary power, remote power, your auto sound system's input, and speakers).
3. Using the mounting holes on the amplifier as a guide, mark the positions for the mounting holes.
4. Drill $\frac{9}{64}$ -inch (3.57 mm) holes at the marked locations, being careful not to damage anything behind the mounting surface.

Note: If you have not already done so, be sure to mark each wire with the name of the terminal you will reconnect it to.

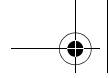

5. Secure the amplifier to the mounting surface using the supplied sheet metal screws and washers.
6. Reconnect the wiring.
7. Reconnect the cable to the vehicle battery's negative (-) terminal.
8. Reset your vehicle's clock, your auto sound system's tuner memory, and other timer/memory devices.

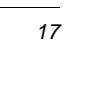
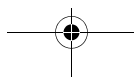
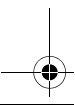
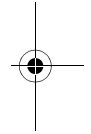
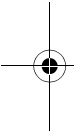

□ Operation

TURNING ON THE AMPLIFIER

The amplifier automatically turns on a few seconds after you turn your vehicle's ignition switch to ACC or ON or turn on your auto sound system, depending on how you wired the system. The **POWER** indicator on the side of the amplifier lights when the amplifier is on.

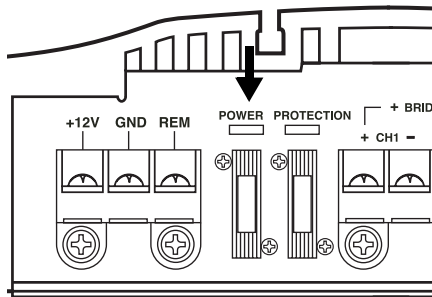

Important: Your amplifier requires 31 amps or more of power from your vehicle's battery during operation. To protect your battery from discharging, do not operate the amplifier unless your vehicle is running.

Note: Your amplifier temporarily shuts down if it gets too hot, then restarts automatically once it cools.

ADJUSTING THE AUDIO LEVEL

For the best performance, you must set **LEVEL (MIN/MAX)** on the left and right sides of the amplifier to adjust the level of the audio signals that enter the amplifier.

1. Use a screwdriver to turn **LEVEL (MIN/MAX)** on the left and right sides of the amplifier fully counterclockwise to **MIN**.

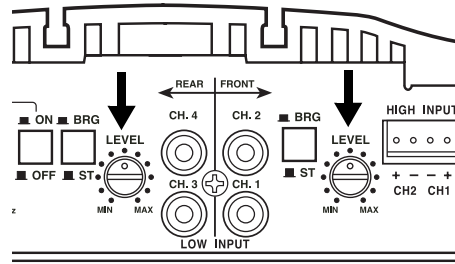

2. Turn the auto sound system's volume control to about one-third of its full range.
 3. On the left and right sides of the amplifier, adjust **LEVEL (MIN/MAX)** to a comfortable listening level.
 4. Turn up the auto sound system's volume control until the sound begins to distort. Then immediately turn the volume down to a point just before where the distortion began.
- Caution:** Never turn up the auto sound system's volume control more than needed to adjust the audio level, or more than two-thirds of its maximum volume.
5. On the left and right sides of the amplifier, adjust **LEVEL (MIN/MAX)** until the sound is at the maximum level you want the amplifier to produce.
 6. Adjust the auto sound system's volume control to a comfortable listening level.

ADJUSTING FREQUENCY CROSSOVER

If you installed a subwoofer using the steps in "Connecting Two Speakers and One Subwoofer (Unbridged Connection)" on Page 14 or "Connecting Two Unbridged Speakers and One Bridged Subwoofer" on Page 15, set **X-OVER FREQ ON/OFF** to **ON**, then adjust **X-OVER FREQ** for your particular vehicle's acoustics. The amplifier passes through all frequencies at or below that setting (45–400 Hz).

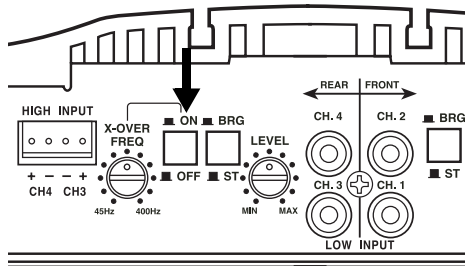

Note: **X-OVER FREQ** selects the limit at which the amplifier will pass frequencies (from 45–400 Hz). You should not use it to adjust the sound you hear through your main speakers.

□ Troubleshooting

We do not expect you to have any problems with your RadioShack High Power 4/3/2-Channel Bridgeable Amplifier, but if you do have a problem, this chart might help. If not, take the amplifier to your local RadioShack store for assistance.

Symptom	Possible Cause	Suggestion
No power — the amplifier's POWER indicator does not light after the vehicle's auto sound system is turned on	Power problem.	Check the amplifier's and auto sound system's fuses and replace them if necessary (see "Replacing a Fuse" on Page 22).
	Vehicle's ignition not turned on.	Start the vehicle.
	Amplifier not connected to auto sound system/vehicle correctly.	Check all connections.
No sound	Auto sound system not turned on or volume set to minimum.	Turn the auto sound system on or adjust its volume.
	Amplifier's LEVEL (MIN/MAX) controls set to minimum.	Adjust LEVEL (MIN/MAX) .
	Amplifier not connected to auto sound system/vehicle correctly.	Check all connections.
	The amplifier might have shut down.	Turn your auto sound system off and let the amplifier cool. Make sure the amplifier is properly ventilated. Then turn your auto sound system back on. The amplifier turns itself back on when it is cooled.
		The amplifier detected an input overload. Reduce the auto sound system's volume.
	Power problem.	Check the amplifier's and auto sound system's fuses and replace them if necessary (see "Replacing a Fuse" on Page 22).
Distorted sound	The amplifier might be receiving too much input power from your auto sound system.	Reduce your auto sound system's output power (if possible), or reduce the auto sound system's volume.

Symptom	Possible Cause	Suggestion
Distorted sound (continued)	The amplifier might have shut down.	Turn your auto sound system off and let the amplifier cool. Make sure the amplifier is properly ventilated. Then turn your auto sound system back on. The amplifier turns itself back on when it is cooled.
	An output channel might have shorted.	Take the amplifier to your local RadioShack store.
The amplifier's PROTECTION indicator lights	Amplifier not connected to auto sound system correctly.	Check all connections.
	The amplifier might be receiving too much power from your auto sound system.	Reduce your auto sound system's output power (if possible), or reduce the auto sound system's volume.

CARE

To enjoy your amplifier for a long time:

- Keep the amplifier dry. If it gets wet, wipe it dry immediately.
- Use and store the amplifier only in normal temperature environments.
- Handle the amplifier gently and carefully. Do not drop it.
- Keep the amplifier away from dust and dirt.
- Wipe the amplifier with a damp cloth occasionally to keep it looking new.

Modifying or tampering with the amplifier's internal components can cause a malfunction and might invalidate its warranty and void your FCC authorization to operate it. If your amplifier is not performing as it should, take it to your local RadioShack store for assistance.

REPLACING A FUSE

If the amplifier does not operate, you might need to replace the red power cable's 40-amp SFE-type fuse or one or both of the 20-amp blade-type fuses on the amplifier's back panel. Check all fuses.

Important: Let the amplifier cool down and see if it starts again before you assume a fuse needs to be replaced.

Caution: Do not use a fuse with ratings other than those specified. Doing so might damage your amplifier.

Replacing the SFE-Type Fuse

1. Disconnect the cable from the vehicle's negative (-) battery terminal.

2. Push together and twist the fuse holder's parts on the red power cable until they spring apart. Then remove the fuse.

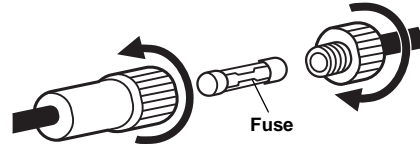

3. If the fuse is blown, replace it. Use only an SFE-type fuse with the proper rating (available at many automotive supply stores). The fuse must be 40 amps.
4. Reassemble the fuse holder by inserting the fuse into the longer of the fuse holder's ends, and pushing together and twisting the two parts until they latch together.
5. Reconnect the cable to the vehicle's negative (-) battery terminal.

Replacing the Blade-Type Fuses

1. Disconnect the cable from the vehicle's negative (-) battery terminal.
2. For each fuse, grasp its plastic end and pull it out of the back of the amplifier.

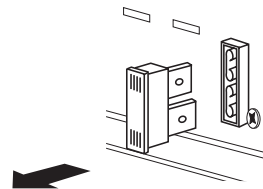

3. If the fuse is blown, replace it. Use only a blade-type fuse with the proper rating. The fuse must be 20 amps.
4. Grasp the fuse's plastic end and push it in.
5. Reconnect the cable to the vehicle's negative (-) battery terminal.

Specifications

Output Power:

Stereo	45 Watts × 4 @ 4 Ohms, 20–20 kHz, 0.5% THD
	65 Watts × 4 @ 4 Ohms, 20–20 kHz, 10% THD
	60 Watts × 4 @ 2 Ohms, 20–20 kHz, 1% THD
Bridged	130 Watts @ 4 Ohms, 1 kHz, 10% THD
Frequency Response	20–20,000 Hz (±3 dB)
Power Supply Voltage	14.4 V DC Negative Ground
Maximum Current Draw	40 A
Dimensions (HWD)	2 ⁵ / ₈ × 10 ¹ / ₄ × 14 ¹ / ₂ Inches (6.0 × 26 × 37 cm)
Net Weight	7.0 lbs (3.2 kg)

Specifications are typical; individual units might vary. Specifications are subject to change and improvement without notice.

Limited One-Year Warranty

This product is warranted by RadioShack against manufacturing defects in material and workmanship under normal use for one (1) year from the date of purchase from RadioShack company-owned stores and authorized RadioShack franchisees and dealers. EXCEPT AS PROVIDED HEREIN, RadioShack MAKES NO EXPRESS WARRANTIES AND ANY IMPLIED WARRANTIES, INCLUDING THOSE OF MERCHANTABILITY AND FITNESS FOR A PARTICULAR PURPOSE, ARE LIMITED IN DURATION TO THE DURATION OF THE WRITTEN LIMITED WARRANTIES CONTAINED HEREIN. EXCEPT AS PROVIDED HEREIN, RadioShack SHALL HAVE NO LIABILITY OR RESPONSIBILITY TO CUSTOMER OR ANY OTHER PERSON OR ENTITY WITH RESPECT TO ANY LIABILITY, LOSS OR DAMAGE CAUSED DIRECTLY OR INDIRECTLY BY USE OR PERFORMANCE OF THE PRODUCT OR ARISING OUT OF ANY BREACH OF THIS WARRANTY, INCLUDING, BUT NOT LIMITED TO, ANY DAMAGES RESULTING FROM INCONVENIENCE, LOSS OF TIME, DATA, PROPERTY, REVENUE, OR PROFIT OR ANY INDIRECT, SPECIAL, INCIDENTAL, OR CONSEQUENTIAL DAMAGES, EVEN IF RadioShack HAS BEEN ADVISED OF THE POSSIBILITY OF SUCH DAMAGES.

Some states do not allow limitations on how long an implied warranty lasts or the exclusion or limitation of incidental or consequential damages, so the above limitations or exclusions may not apply to you.

In the event of a product defect during the warranty period, take the product and the RadioShack sales receipt as proof of purchase date to any RadioShack store. RadioShack will, at its option, unless otherwise provided by law: (a) correct the defect by product repair without charge for parts and labor; (b) replace the product with one of the same or similar design; or (c) refund the purchase price. All replaced parts and products, and products on which a refund is made, become the property of RadioShack. New or reconditioned parts and products may be used in the performance of warranty service. Repaired or replaced parts and products are warranted for the remainder of the original warranty period. You will be charged for repair or replacement of the product made after the expiration of the warranty period.

This warranty does not cover: (a) damage or failure caused by or attributable to acts of God, abuse, accident, misuse, improper or abnormal usage, failure to follow instructions, improper installation or maintenance, alteration, lightning or other incidence of excess voltage or current; (b) any repairs other than those provided by a RadioShack Authorized Service Facility; (c) consumables such as fuses or batteries; (d) cosmetic damage; (e) transportation, shipping or insurance costs; or (f) costs of product removal, installation, set-up service adjustment or reinstallation.

This warranty gives you specific legal rights, and you may also have other rights which vary from state to state.

RadioShack Customer Relations, 200 Taylor Street, 6th Floor, Fort Worth, TX 76102

We Service What We Sell

12/99

RadioShack
A Division of Tandy Corporation
Fort Worth, Texas 76102

12-2017
05A00
Printed in China